

Job Name: _____	Client Name: _____
Job Location - City: _____ State: _____	Created By: _____ Date: _____
Product: _____ Quote: _____	Customer Approval: _____ Date: _____

**SPECIFICATIONS**

**Transformer Base** - The aluminum transformer base is accepted by the Federal Highway Administration (FHWA) as satisfying up to the LTS-6 edition of the American Association of State Highway and Transportation Officials' (AASHTO) breakaway requirements within the range of conditions tested. This base has specific loading restriction based on full scale testing performed by Valmont per the criteria set forth in the 2009 Fifth Edition of the AASHTO Standard Specification for the Supports for Highway Signs, Luminaries and Traffic Signals. Contact Valmont for loading restrictions.

**Access Door** - An aluminum access door and grounding provision is provided. The door opening is 5.00" tall, 7.25" wide. A plastic door is available upon request.

**Hardware** - Connecting bolts, flat washers, bearing washers and hex nuts are provided per base assembly. All structural fasteners are galvanized high strength carbon steel. All non-structural fasteners are galvanized or zinc-plated carbon steel or stainless steel.

**Finish** - The satin finish is provided when ordering with an aluminum structure. A mill finish is provided when ordering with a steel structure. Additional finishes available upon request.

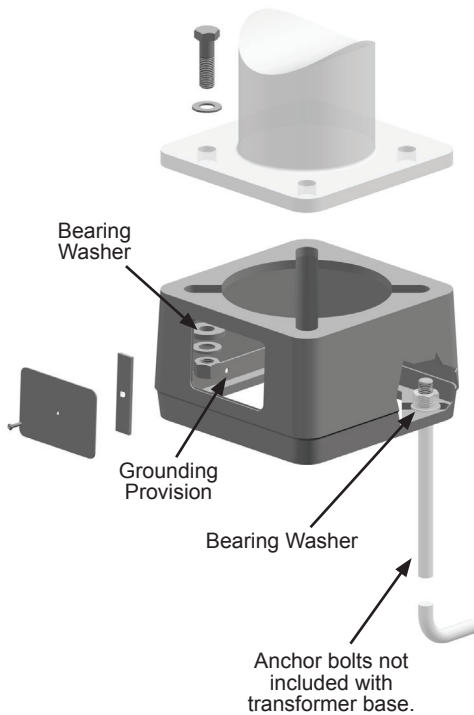

**DETAILS**

TOP PLATE					BOTTOM PLATE					HEIGHT (IN)	QTY OF ACCESS DOORS	MODEL NUMBER
BOLT CIRCLE			SQUARE (IN)	THK (IN)	BOLT CIRCLE			SQUARE (IN)	THK (IN)			
DIA (IN)	± (IN)	MAX BOLT DIA (IN)			DIA (IN)	± (IN)	MAX BOLT DIA (IN)					
14.75	0.25	1.25	14.75	0.625	15.38	0.88	1.25	15.31	0.625	9.00	1	CS370

Top Detail

Bottom Detail

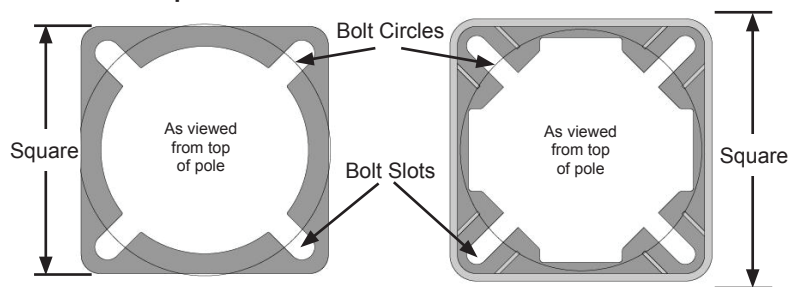

**INSTALLATION INSTRUCTIONS**

1. Level transformer base with shims only. DO NOT USE LEVELING NUTS.
2. To approach optimum static loads, use the largest possible bolt circles and hardware supplied with the transformer base.

**PRODUCT ORDERING CODES**

MODEL NUMBER	FINISH	COLOR	OPTIONS
CS370	-- = Satin / Mill FP = Finish Paint	-- = Satin / Mill WH = White BK = Black SM = Silver Metallic SL = Silver LG = Light Gray MB = Medium Bronze CB = Bronze DB = Dark Bronze SC = Special Color (Contact Factory)	