



DECORATIVE LAMP POST

FLUTED TAPERED POLE

- Fluted, tapered composite pole
- Direct Embedded and Anchor Base models
- XTREME® elastomeric urethane base cover

POLE **CF10**
DECORATIVE BASE **D1M**

Ordering Information

SAMPLE CATALOG NUMBER LOGIC

	B	C	D	E	F
CF10-D1M	17	DE	DGR	40	
CF10-D1M	21	AB	BLK	30	RC
BASE & POLE DESIGN	ABOVE GRADE HEIGHT	INSTALLATION METHOD	COLOR	TENON O.D.	OPTIONS

B ABOVE GRADE HEIGHT

Cat No.	Description
6	6 feet/1.8M
7	7 feet/2.1M
8	8 feet/2.4M
9	9 feet/2.7M
10	10 feet/3.0M
11	11 feet/3.4M
12	12 feet/3.7M
13	13 feet/4.0M
14	14 feet/4.3M
15	15 feet/4.6M
16	16 feet/4.9M
17	17 feet/5.2M
18	18 feet/5.5M
19	19 feet/5.8M
20	20 feet/6.1M
21	21 feet/6.4M

E TENON O.D. (OUTSIDE DIAMETER)

Cat No.	Description
30	3" (76mm) O.D. x 3" (76mm) height
40	4" (102mm) O.D. x 6" (178mm) height
99	Custom Tenon Size

F OPTIONS

Cat No.	Description
RC	Receptacle housing and a NEC approved cover. GFCI receptacle included. Standard location is 12"/305mm below the top of the pole.

- Other accessories are shown on the Accessories specification sheet.

C INSTALLATION METHOD

Cat No.	Description
DE	Direct Embedded
AB	Anchor Base

D COLOR

Cat No.	Description
BLK	Black
DBZ	Dark Bronze
DGR	Dark Green
SLV	Silver
WHT	White
GRY	Grey
CC	Custom color - Please provide a min. 3" x 3" color chip.
RAL	Please provide a four digit RAL color number.



ABOVE GRADE HEIGHT
20' MODEL SHOWN

HEIGHT: 54"/1370MM
BASE DIAMETER: 20"/510MM

Whatley - Valmont Composite Structures, Inc.

19845 U.S. Highway 76 • Newberry, SC 29108 USA

Tel: 877.959.7678 | 803.276.5507 • Fax: 803.276.8940 • whatley.com

Direct Embedded - DE

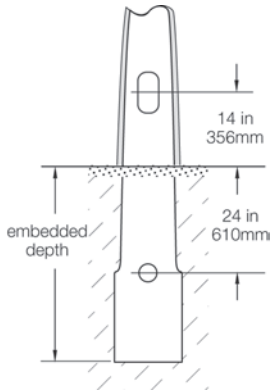

SHAFT LENGTH	EMBEDDED DEPTH
6 to 13 feet	3ft/.91M
14 to 25 feet	4ft/1.2M

* Embedded depths may vary per local codes, site soil conditions, drainage and very high wind conditions.

Anchor Base Installation - AB

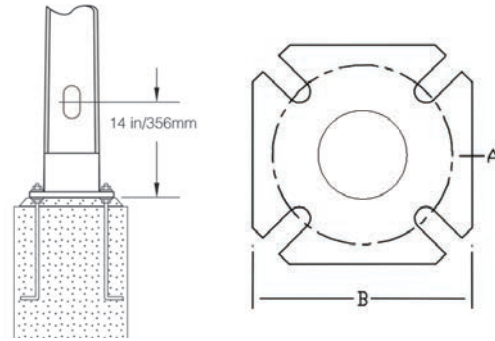

Shaft Length	A	B	Anchor Bolts
6' to 21' (1.8M to 6.4M)	9" to 11" (229mm-279mm)	10" (254mm)	3/4" x 30"

Specifications

POLE SHAFT

The CF10 pole shaft shall be round tapered, smooth with 10 flutes and a .108"/2.7mm per foot taper. The hand hole shall be 2.5"/64mm x 5"/127mm with a cover. The shaft shall be constructed of fiberglass combined with a thermosetting resin using an advanced centrifugal cast process. The hand hole area and hardware attachment areas shall be reinforced.

The butt end of the embedded-type post shall be shaped to increase the resistance to rotation. The post shall be non-conductive and chemically inert.

PERFORMANCE CRITERIA

The post shall be designed with a minimum safety factor of 1.5:1 and have no more than a 15% deflection at full wind loading. The post shall deflect no more than 2.5% of the above-ground length with 100 lbs. of lateral top load. Poles shall be tested and rated per ANSI C136.20-2012.

DIRECT EMBEDDED INSTALLATION

Direct embedded poles shall have two 2.5 inch (64mm) diameter holes at 180° for conduit entrance 24 inches (610mm) below finished grade. Embedded depths may vary per local codes, site soil conditions, drainage and very high wind conditions.

ANCHOR BASE

Anchor bases shall be constructed of hot dipped galvanized steel. The base shall be factory bonded to the pole. The anchor base shall have four holes at ninety degrees, accommodating a bolt circle as indicated in the chart.

POST TOP

A painted aluminum or galvanized steel tenon shall be factory bonded to the pole for mounting a post-top luminaire or arm.

FINISH

The surface of the post shall be uniform and consistent for the entire length of the post. A UV-resistant catalyzed urethane coating shall be extremely durable and retains its gloss after a 5000 hour exposure test (ASTM G-154), with no dulling or chalking of the surface.

ORNAMENTAL BASE COVER

The ornamental decorative base cover shall be one or two piece and constructed of a proprietary elastomeric urethane and finished to match the post. The base shall be corrosion free and extremely resistant to impact and chipping.

WARRANTY

The products shall be warranted to be free of defects for three years from the date of shipment from the factory.

Wind Loading Data for

Direct Embedded and Anchor Base

Cat No.	Description	WT	WIND SPEED (MPH) WITH 3 SECOND GUST FACTOR						
			90	100	110	120	130	140	150
6	6 feet/1.8M	42	40.0	32.1	26.3	21.8	18.4	15.6	13.4
7	7 feet/2.1M	47	37.0	29.7	24.3	20.2	17.0	14.5	12.4
8	8 feet/2.4M	53	33.2	26.7	21.8	18.1	15.2	12.9	11.1
9	9 feet/2.7M	58	31.4	25.2	20.5	17.1	14.4	12.2	10.5
10	10 feet/3.0M	64	29.3	23.5	19.2	15.9	13.4	11.3	9.7
11	11 feet/3.4M	69	28.3	22.7	18.5	15.3	12.9	10.9	9.4
12	12 feet/3.7M	75	27.2	21.8	17.7	14.7	12.3	10.5	9.0
13	13 feet/4.0M	81	26.0	20.8	16.9	14.0	11.7	9.9	8.5
14	14 feet/4.3M	86	24.7	19.7	16.0	13.2	11.1	9.4	8.0
15	15 feet/4.6M	92	23.5	18.8	15.2	12.6	10.5	8.9	7.6
16	16 feet/4.9M	97	22.6	18.0	14.6	12.0	10.1	8.5	7.2
17	17 feet/5.2M	103	21.4	17.0	13.8	11.3	9.4	8.0	6.8
18	18 feet/5.5M	86	20.3	16.1	13.0	10.7	8.9	7.5	6.3
19	19 feet/5.8M	92	19.2	15.2	12.2	10.0	8.3	7.0	5.9
20	20 feet/6.1M	97	18.0	14.2	11.4	9.3	7.7	6.4	5.4
21	21 feet/6.4M	103	16.8	13.2	10.6	8.6	7.1	5.9	5.0

Wind speed values are for a 3-second gust per ASCE 7-05. Calculated per ANSI C136.20-2012. Assumes load 12 inches above the pole top. Safety factor = 1.5:1. Maximum weight for tenon mount is 100 lbs.

Contact factory for AASHTO or specific local codes.