



# DECORATIVE LAMP POST

POLE **TS34**

## TAPERED SMOOTH POLE

DECORATIVE BASE **D7M**

- Tapered, smooth composite pole shaft
- Direct Embedded and Anchor Base models
- XTREME® elastomeric urethane base cover

### Ordering Information

SAMPLE CATALOG NUMBER LOGIC

	B	C	D	E	F
TS34-D7M	16	DE	DGR	40	
TS34-D7M	20	AB	BLK	35	RC
BASE & POLE DESIGN	ABOVE GRADE HEIGHT	INSTALLATION METHOD	COLOR	TENON O.D.	OPTIONS

#### B ABOVE GRADE HEIGHT

Cat No.	Description
10	10 feet/3.0M
11	11 feet/3.4M
12	12 feet/3.7M
13	13 feet/4.0M
14	14 feet/4.3M
15	15 feet/4.6M
16	16 feet/4.9M
17	17 feet/5.2M
18	18 feet/5.5M
19	19 feet/5.8M
20	20 feet/6.1M
21	21 feet/6.40M
22	22 feet/6.71M
23	23 feet/7.01M
24	24 feet/7.32M
25	25 feet/7.62M
26	26 feet/7.92M
27	27 feet/8.32M
28	28 feet/8.53M
29	29 feet/8.84M
30	30 feet/9.14M

#### C INSTALLATION METHOD

Cat No.	Description
DE	Direct Embedded
AB	Anchor Base

#### D COLOR

Cat No.	Description
BLK	Black
MTB	Matte Black
DBZ	Dark Bronze
DGR	Dark Green
HTG	Hunter Green
SLV	Silver
WHT	White
GRY	Grey
CC	Custom color - Please provide a min. 3" x 3" color chip.
RAL	Please provide a four digit RAL color number.

#### E TENON O.D. (OUTSIDE DIAMETER)

Cat No.	Description
23	2 3/8" (60 mm)
27	2 7/8" (73mm)
30	3" (76 mm) nominal
35	3 1/2" (89 mm)
40	4" (102 mm)

Tenons include a cast decorative ring at the top of the pole.

- For other tenon sizes contact the factory.

#### F OPTIONS

Cat No.	Description
RC	Receptacle housing and a NEC approved cover. GFCI receptacle by others. Standard location is 12"/305mm below the top of the pole.

- Other accessories are shown on the Accessories specification sheet.

ABOVE GRADE HEIGHT

20' MODEL SHOWN



HEIGHT: 42"/1067MM

BASE DIAMETER: 18"/457MM

**Whatley - Valmont Composite Structures, Inc.**

19845 U.S. Highway 76 • Newberry, SC 29108 USA

Tel: 877.959.7678 | 803.276.5507 • Fax: 803.276.8940 • [whatley.com](http://whatley.com)

**Direct Embedded - DE**

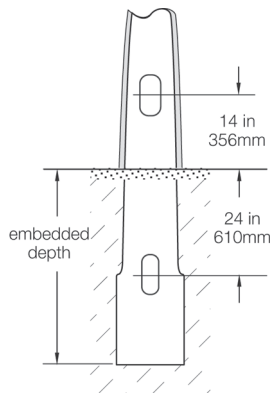

SHAFT LENGTH	EMBEDDED DEPTH
10 to 13 feet	3ft/.91M
14 to 24 feet	4ft/1.2M
25 to 30 feet	5ft/1.5M

\* Embedded depths may vary per local codes, site soil conditions, drainage and very high wind conditions.

Hand hole is:  
2.5"/62mm x 5"/125mm.

**Anchor Base Installation - AB**

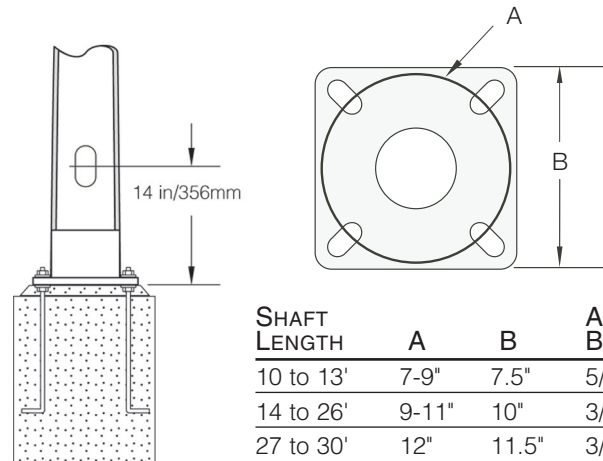

SHAFT LENGTH	A	B	ANCHOR BOLTS
10 to 13'	7-9"	7.5"	5/8" x 20"
14 to 26'	9-11"	10"	3/4" x 30"
27 to 30'	12"	11.5"	3/4" x 30"

**Specifications**

**POLE SHAFT**

The pole shaft shall be round tapered, smooth with a .14"/3.5mm per foot taper. The hand hole shall be 2.5"/62mm x 5"/125mm with a cover. The shaft shall be constructed of continuous fiberglass filament combined with a thermosetting resin. The glass filament shall be helically wound at alternating high and low angle layers for maximum compressive and bending strength. The hand hole area and hardware attachment areas shall be reinforced. The poles shall be designed with a minimum safety factor of 1.5:1 and have a maximum deflection of 15% under full wind loading conditions.

The butt end of the embedded-type post shall be enlarged and oval to increase the resistance to rotation and provide maximum ground bearing resistance (anti-lift). The post shall be non-conductive and chemically inert.

**PERFORMANCE CRITERIA**

The post shall be designed with a minimum safety factor of 1.5:1 and have no more than a 15% deflection at full wind loading. The post shall deflect no more than 2.5% of the above-ground length with 100 lbs. of lateral top load. Poles shall be tested and rated per ANSI C136.20-2012.

**DIRECT EMBEDDED INSTALLATION**

Direct embedded poles shall have a 2.5 inch (62mm) by 6 inch (152mm) slot for conduit entrance 24 inches (610mm) below finished grade. Embedded depths may vary per local codes, site soil conditions, drainage and very high wind conditions.

**ANCHOR BASE**

Anchor bases shall be constructed of primed and painted aluminum or galvanized steel. The base shall be factory bonded to the post. The anchor base shall have four holes at ninety degrees, accommodating a bolt circle of 7-9 inches, 9-11 inches or 12 inches.

**POST TOP**

A painted aluminum or galvanized steel tenon shall be firmly bonded to the pole for mounting a post-top luminaire or arm.

**FINISH**

The surface of the post shall be uniform and consistent for the entire length of the post. A UV-resistant catalyzed urethane coating shall be extremely durable and retains its gloss after a 5000 hour exposure test (ASTM G-154) to the sun, with no dulling or chalking of the surface.

**ORNAMENTAL BASE COVER**

The ornamental decorative base cover shall be one or two piece and constructed of a proprietary elastomeric urethane and finished to match the post. The base shall be corrosion free and extremely resistant to impact and chipping.

**WARRANTY**

The products shall be warranted to be free of defects for three years from the date of shipment from the factory.

**Wind Loading Data for**

**Direct Embedded and Anchor Base**

Cat No.	Description	WT	WIND SPEED (MPH) WITH 3 SECOND GUST FACTOR							
			90	100	110	120	130	140	150	
10	10 feet/3.10M	26	11.8	9.2	7.5	6.2	5.2	4.4	3.8	
11	11 feet/3.35M	29	11.3	8.8	7.2	5.9	5.0	4.2	3.6	
12	12 feet/3.66M	31	10.2	8.0	6.5	5.3	4.4	3.7	3.2	
13	13 feet/3.96M	34	9.4	7.4	5.9	4.9	4.1	3.4	2.9	
14	14 feet/4.27M	37	8.7	6.8	5.5	4.5	3.7	3.1	2.6	
15	15 feet/4.57M	38	9.2	8.0	6.5	5.3	4.4	3.7	3.1	
16	16 feet/4.88M	42	9.3	7.3	5.9	4.8	4.0	3.3	2.8	
17	17 feet/5.18M	45	8.6	6.7	5.4	4.4	3.6	3.0	2.5	
18	18 feet/5.49M	49	7.9	6.1	4.9	3.9	3.2	2.7	2.2	
19	19 feet/5.79M	51	7.2	5.6	4.4	3.6	2.9	2.4	2.0	
20	20 feet/6.10M	52	6.6	5.1	4.0	3.2	2.6	2.1	1.8	
21	21 feet/6.40M	75	8.2	6.4	5.1	4.1	3.4	2.8	2.3	
22	22 feet/6.71M	77	7.5	5.8	4.6	3.7	3.0	2.5	2.1	
23	23 feet/7.01M	80	6.9	5.3	4.2	3.3	2.7	2.2	1.8	
24	24 feet/7.32M	83	6.3	4.9	3.8	3.0	2.4	2.0	1.6	
25	25 feet/7.62M	85	5.8	4.4	3.4	2.7	2.1	1.7	1.3	
26	26 feet/7.92M	88	5.3	4.0	3.1	2.4	1.9	1.5	1.1	
27	27 feet/8.32M	91	4.9	3.6	2.8	2.1	1.7	1.3	0.9	
28	28 feet/8.53M	93	4.4	3.3	2.5	1.9	1.4	1.1	0.7	
29	29 feet/8.84M	96	3.9	2.9	2.1	1.6	1.2	0.9	0.5	
30	30 feet/9.14M	99	3.5	2.5	1.8	1.3	1.0	0.7	0.3	

Wind speed values are for a 3-second gust per ASCE. Calculated per ANSI C136.20-2012. Assumes load 12 inches above the pole top. Safety factor = 1.5:1. Maximum weight for tenon mount is 100 lbs.

Contact factory for AASHTO or specific local codes.