

T-SERIES DEADEND CROSSARM MODEL - TDB144G12482

Strong, Durable Composite Deadend Crossarm Assembly

Engineered for robust performance, Shakespeare fiberglass composite deadend crossarm assemblies serve as the anchoring points along transmission and distribution lines. Shakespeare crossarms are a great choice for use on composite, concrete, steel, aluminum or wood utility poles. Often, composite crossarms are twice the strength and half the weight of their wood counterparts.

- 3-1/2" x 4-1/2" x 12' Deadend Assembly
- Lightweight - Easy to Install
- Environmentally Safe
- No Preservatives
- Triple UV Protection
- Grey in Color
- Optimal Deflection Mitigation Design
- Will Not Rot, Splinter or Corrode
- Impervious to Insects, Woodpeckers
- Excellent Dielectric Properties
- Excellent Toughness and Impact Strength
- Standard Installation - No Special Tools Needed

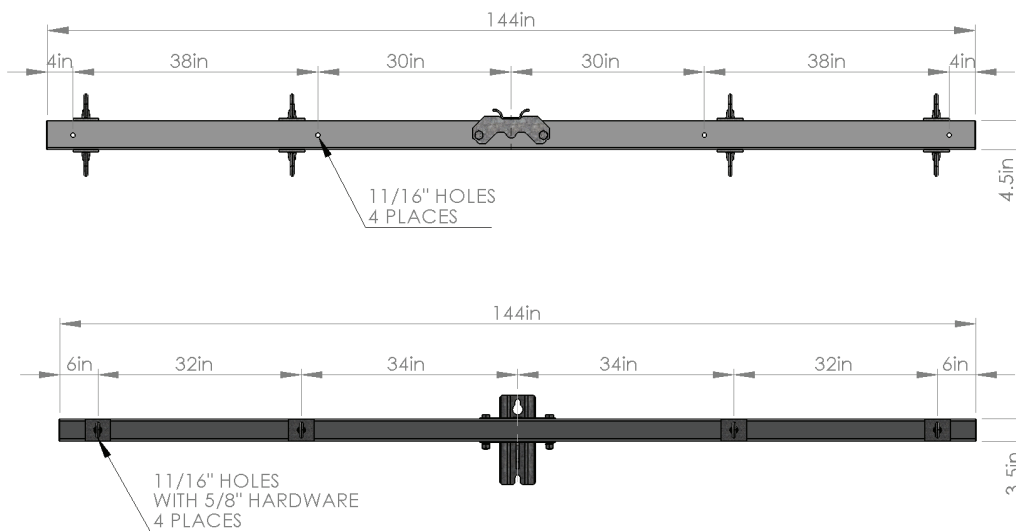

	ULTIMATE LOAD PER WIRE (lbs)	DEFLECTION PER 1000 (in)	WEIGHT (lbs)	GUY WIRE RATING EACH (lbs)	MOMENT OF INERTIA ABOUT THE NEUTRAL AXIS (in ⁴)	SECTION MODULUS ABOUT THE NEUTRAL AXIS (in ³)	BENDING STRESS (psi)	MOMENT @ FAILURE (in/lbs)	FLEXURAL MODULUS (psi)
4 WIRE RATINGS	6,060	1.70"	85	30,000	14.37	6.39	85,438	545,950	5.75E + 06

TESTING PER ASTM D8019-15

T-SERIES DEADEND CROSSARM - TDB144G12482

REFERENCE STANDARDS

ASTM A153 (Zinc Coating); ASTM D635 (Burning of Self Supporting Plastics); ASTM G154 (Operating light and water exposure apparatus for non-metallic materials); ASTM D8019-15 (Determining the full section flexural modulus and bending strength of fiber reinforced polymer crossarms assembled with center brackets).

WEATHER AND UV PROTECTION

UV inhibitors shall be added to the resin system and the outside surface of the crossarm shall be covered with a polyester surface veil to prevent fiber bloom. Also, the arm shall be coated with a minimum of 1.5 mils of UV resistant coating. Crossarms shall be tested for a minimum of 15,000 hrs on the veil surface and 15,000 hrs on the coated surface or a combined test of 30,000 hrs with QUV-A per ASTM G154 with 4-hour light cycle and 4-hour humidity cycle.

FOAM FILLING

Crossarms shall be foam filled with a closed cell high density foam to prevent water ingress and must completely fill the crossarm and adhere to the inside walls.

MOUNTING BRACKET OR HARDWARE

Mounting brackets shall be manufactured from hot dipped galvanized steel using 50,000 psi steel. All bolts, nuts and other hardware to be hot dipped galvanized.

END CAPS

Crossarm shall be sealed with non-removable flush mounted inserts. External caps are not acceptable.

MECHANICAL STRENGTHS

The ultimate strengths should be listed per ASTM D8019-15. Compressive strength in both the vertical and horizontal directions shall be a minimum of 500 psi without permanent deformation or damage to the fiber/ resin matrix.

ELECTRICAL CHARACTERISTICS

Fiberglass crossarms shall have an average 60 Hz BIL of no less than 15 kV/inch and an average wet 60 Hz BIL of no less than 12 kV/inch.

IDENTIFICATION

Each fiberglass crossarm shall be permanently marked with the manufacturer's name or logo and the date of manufacture.

PACKAGING

Fiberglass crossarm shall be shipped fully assembled.

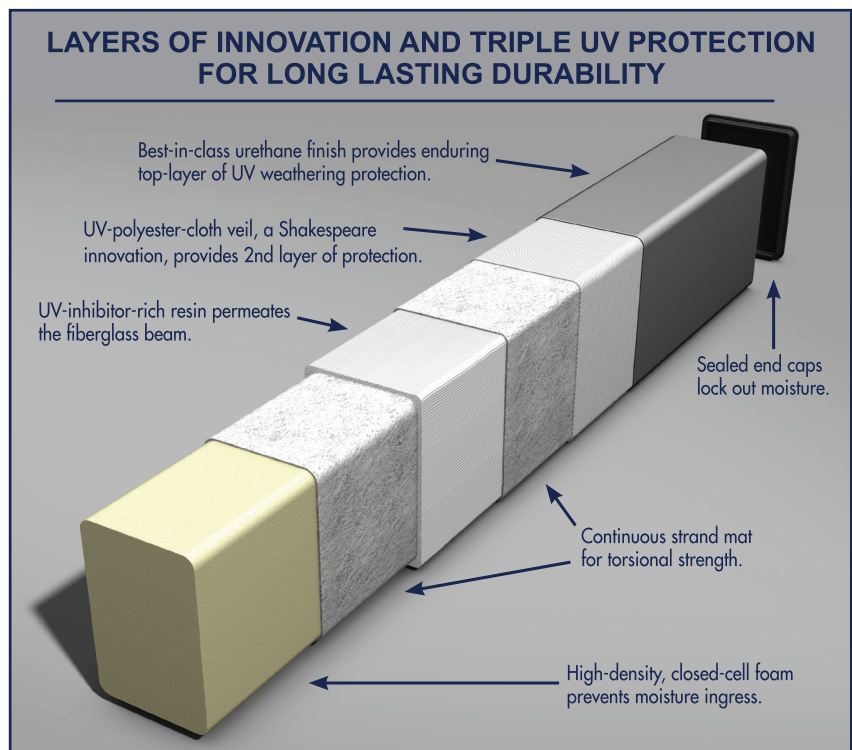

SFC7726 01/17 skp-cs.com carries the most current spec information and supercedes these guidelines.