



# DECORATIVE LAMP POST

POLE **CF10**  
DECORATIVE BASE **D16M**

## FLUTED TAPERED POLE

- Fluted, tapered composite pole
- Direct Embedded and Anchor Base models
- XTREME® elastomeric urethane base cover

### Ordering Information

#### SAMPLE CATALOG NUMBER LOGIC

	B	C	D	E	F
CF10-D16M	17	DE	DGR	40	
CF10-D16M	19	AB	BLK	30	RC
BASE & POLE DESIGN	ABOVE GRADE HEIGHT	INSTALLATION METHOD	COLOR	TENON O.D.	OPTIONS

#### B ABOVE GRADE HEIGHT

Cat No.	Description
6	6 feet/1.8M
7	7 feet/2.1M
8	8 feet/2.4M
9	9 feet/2.7M
10	10 feet/3.0M
11	11 feet/3.4M
12	12 feet/3.7M
13	13 feet/4.0M
14	14 feet/4.3M
15	15 feet/4.6M
16	16 feet/4.9M
17	17 feet/5.2M
18	18 feet/5.5M
19	19 feet/5.8M

#### E TENON O.D. (OUTSIDE DIAMETER)

Cat No.	Description
30	3" (76mm) O.D. x 3" (76mm) height
40	4" (102mm) O.D. x 6" (178mm) height
99	Custom Tenon Size

#### F OPTIONS

Cat No.	Description
RC	Receptacle housing and a NEC approved cover. GFCI receptacle included. Standard location is 12"/305mm below the top of the pole.

- Other accessories are shown on the Accessories specification sheet.

#### C INSTALLATION METHOD

Cat No.	Description
DE	Direct Embedded
AB	Anchor Base

#### D COLOR

Cat No.	Description
BLK	Black
DBZ	Dark Bronze
DGR	Dark Green
SLV	Silver
WHT	White
GRY	Grey
CC	Custom color - Please provide a min. 3" x 3" color chip.
RAL	Please provide a four digit RAL color number.

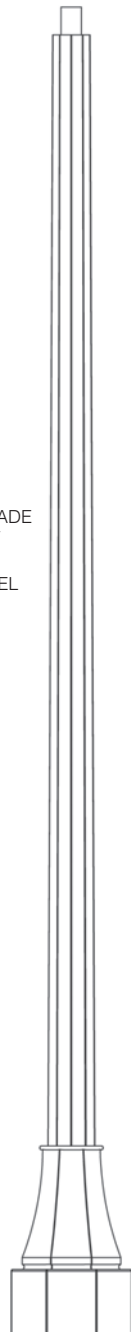

ABOVE GRADE HEIGHT

19' MODEL SHOWN

HEIGHT: 28"/710MM

BASE DIAMETER: 18"/457MM

Whatley - Valmont Composite Structures, Inc.

19845 U.S. Highway 76 • Newberry, SC 29108 USA

Tel: 877.959.7678 | 803.276.5507 • Fax: 803.276.8940 • [whatley.com](http://whatley.com)

**Direct Embedded - DE**

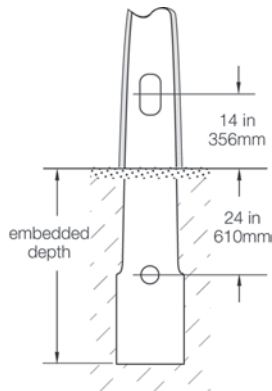

SHAFT LENGTH	EMBEDDED DEPTH
6 to 13 feet	3ft/.91M
14 to 23 feet	4ft/1.2M

\* Embedded depths may vary per local codes, site soil conditions, drainage and very high wind conditions.

**Anchor Base Installation - AB**

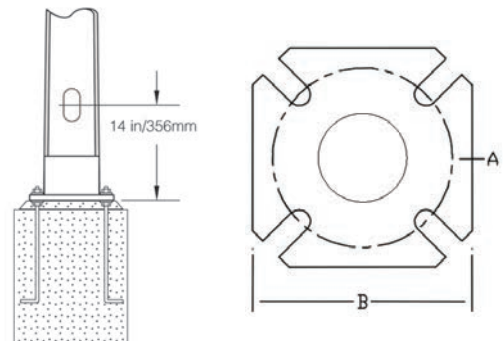

Shaft Length	A	B	Anchor Bolts
6' to 19' (1.8M to 5.8M)	9" to 11" (229mm-279mm)	10" (254mm)	3/4" x 30"

**Specifications**

**POLE SHAFT**

The CF10 pole shaft shall be round tapered, smooth with 10 flutes and a .108"/2.7mm per foot taper. The hand hole shall be 2.5"/64mm x 5"/127mm with a cover. The shaft shall be constructed of fiberglass combined with a thermosetting resin using an advanced centrifugal cast process. The hand hole area and hardware attachment areas shall be reinforced.

The butt end of the embedded-type post shall be shaped to increase the resistance to rotation. The post shall be non-conductive and chemically inert.

**PERFORMANCE CRITERIA**

The post shall be designed with a minimum safety factor of 1.5:1 and have no more than a 15% deflection at full wind loading. The post shall deflect no more than 2.5% of the above-ground length with 100 lbs. of lateral top load. Poles shall be tested and rated per ANSI C136.20-2012.

**DIRECT EMBEDDED INSTALLATION**

Direct embedded poles shall have two 2.5 inch (64mm) diameter holes at 180° for conduit entrance 24 inches (610mm) below finished grade. Embedded depths may vary per local codes, site soil conditions, drainage and very high wind conditions.

**ANCHOR BASE**

Anchor bases shall be constructed of hot dipped galvanized steel. The base shall be factory bonded to the pole. The anchor base shall have four holes at ninety degrees, accommodating a bolt circle as indicated in the chart.

**POST TOP**

A painted aluminum or galvanized steel tenon shall be factory bonded to the pole for mounting a post-top luminaire or arm.

**FINISH**

The surface of the post shall be uniform and consistent for the entire length of the post. A UV-resistant catalyzed urethane coating shall be extremely durable and retains its gloss after a 5000 hour exposure test (ASTM G-154), with no dulling or chalking of the surface.

**ORNAMENTAL BASE COVER**

The ornamental decorative base cover shall be one or two piece and constructed of a proprietary elastomeric urethane and finished to match the post. The base shall be corrosion free and extremely resistant to impact and chipping.

**WARRANTY**

The products shall be warranted to be free of defects for three years from the date of shipment from the factory.

**Wind Loading Data for**

**Direct Embedded and Anchor Base**

Cat No.	Description	WT	WIND SPEED (MPH) WITH 3 SECOND GUST FACTOR						
			90	100	110	120	130	140	150
6	6 feet/1.8M	42	40.0	32.1	26.3	21.8	18.4	15.6	13.4
7	7 feet/2.1M	47	37.0	29.7	24.3	20.2	17.0	14.5	12.4
8	8 feet/2.4M	53	33.2	26.7	21.8	18.1	15.2	12.9	11.1
9	9 feet/2.7M	58	31.4	25.2	20.5	17.1	14.4	12.2	10.5
10	10 feet/3.0M	64	29.3	23.5	19.2	15.9	13.4	11.3	9.7
11	11 feet/3.4M	69	28.3	22.7	18.5	15.3	12.9	10.9	9.4
12	12 feet/3.7M	75	27.2	21.8	17.7	14.7	12.3	10.5	9.0
13	13 feet/4.0M	81	26.0	20.8	16.9	14.0	11.7	9.9	8.5
14	14 feet/4.3M	86	24.7	19.7	16.0	13.2	11.1	9.4	8.0
15	15 feet/4.6M	92	23.5	18.8	15.2	12.6	10.5	8.9	7.6
16	16 feet/4.9M	97	22.6	18.0	14.6	12.0	10.1	8.5	7.2
17	17 feet/5.2M	103	21.4	17.0	13.8	11.3	9.4	8.0	6.8
18	18 feet/5.5M	86	20.3	16.1	13.0	10.7	8.9	7.5	6.3
19	19 feet/5.8M	92	19.2	15.2	12.2	10.0	8.3	7.0	5.9

Wind speed values are for a 3-second gust per ASCE 7-05. Calculated per ANSI C136.20-2012. Assumes load 12 inches above the pole top. Safety factor = 1.5:1. Maximum weight for tenon mount is 100 lbs.

Contact factory for AASHTO or specific local codes.